

## ACCESSORIES

### Car Adapter

Enables you to re-charge your battery with your vehicle's electrical system.



Part No. 900507

### Battery Cell

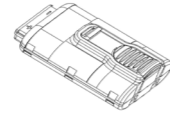

Part No. 018880

### Battery Charger

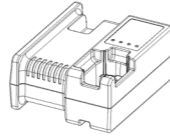

Part No. 018881 (EU)  
018882 (UK)

### Cable

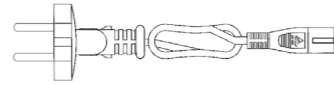

Part No. 018885 (EU)  
018886 (UK)

### 9/65" Hex Key

For cleaning tool

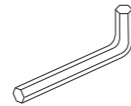

Part No. 900736

### Orange Safety Glasses



Part No. 011117

### Paslode Intensive Tool Cleaner 300 ml

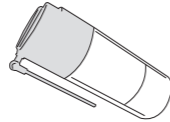

Part No. 115251

### Paslode Impulse Lubricating Oil

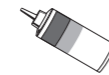

Part No. 401482

### Carrying Case

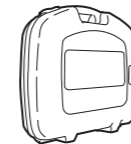

Part No. 014975

### Cleaning Kit

Contains all the necessary to clean any Impulse tool

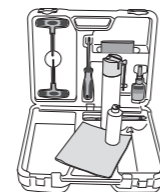

Part No. 013060

# Paslode®

## Impulse®

Part No. 013312 (EU)  
Part No. 013313 (UK)



## IM65A F16 Lithium

### IMPORTANT! DO NOT DESTROY

Always refer to operating and safety instructions (#018909 & #014744) for detailed information on this tool. It is the customer's responsibility to have all operators and service personnel read and understand this information.

## TOOL SCHEMATIC AND PARTS



An Illinois Tool Works Company  
Route de Lyon - BP 104  
F - 26501 Bourg Les Valence - Cedex France

018906-1  
04/13

# LEGEND IM65A F16 Lithium

Part No. 013312 (EU), 013313 (UK)

1	013715	1	Grille	50	903501	1	Handle/Right
* 2	900648	1	Filter	53	018922	1	Fuel Door
3	901064	4	Shoulder Screw 8-32 x 1-3/8"	54	902235	1	Retaining Ring-Pin-Fuel Door
4	018920	1	Cap	55	902434	1	Nut-Utility Hook
5	904557	2	Screw, SHC	56	902433	1	Button
6	901119	1	Retaining Ring	57	902431	1	Block-Utility Hook
7	901382	1	Fan Motor Assembly with Ring	58	902432	1	Spring
*8	401356	1	Motor Sleeve	59	902435	1	Stop Utility Hook
9	900785	1	Insulator	60	902430	1	Utility Hook
10	900714	1	Spark Plug Assembly	61	901044	1	Soft Grip
11	018921	1	Cylinder Head	62	902440	1	Spark Unit (MSU)
15	900697	1	Stem adapter	63	900662	1	ESU Power Wire Assembly
16	900596	1	SEMS Screw, Torx	64	904562	1	Fan Motor Wire Assembly
17	900739	1	Cylinder Head Circuit Board Assy.	65	018927	1	Nameplate
18	900612	4	Seal Ring	66	902621	1	Battery Pad
19	900709	1	Fan Assembly	67	902439	1	Molded Circuit Assembly
20	900700	1	Air Dam	68	900726	1	Switch Slide Assembly
21	900729	1	Combustion Chamber	69	900792	2	Soc. Hd. Shoulder Screw 8-32
22	900707	2	Probe Bumper	70	404702	2	Screw 6-32 x 3/8"
23	900746	2	Screw, #8-32 x 7/16	71	904567	1	Spark Wire Assembly
24	900704	1	Yoke	72	901053	1	Trigger Spring
25	900734	1	Roll Pin	73	901082	1	Trigger Assembly
26	900804	2	Spring Guide Assembly	74	901047	1	Dowel Pin, Trigger
27	902437	1	Knob w/ Yoke Guide Assembly	75	900629	1	Clip/ High Tension
28	902424	1	Probe	76	900770	1	Brad Channel
*29	902425	1	Probe Tip	77	902404	1	Magazine Extrusion
30	013706	1	Latch Cover, Quick Clear Black	78	902421	1	Nose
31	900619	1	Dowel Pin	79	900631	1	Spring, Lockout
32	902457	1	Front Plate Assembly	80	900602	1	Lockout Bar
33	900685	1	Dowel Pin	81	900630	1	Lockout Pin
34	902426	1	Quick Clear Lever Assembly	82	900660	2	Screw 10-32 x 3/8"
35	405140	4	Screw 8-32 x 3/8" (red)	83	900692	1	Retaining Cup
36	900668	1	Muffler Cover	84	900708	2	SHC Screw 8-32 x 1/2" (Red)
37	900609	1	Muffler	85	900754	1	SHC Screw 8-32 x 1/2" (Yellow)
38	900664	1	Reed Valve	86	900722	1	Follower Pin
39	900665	1	Reed Plate	87	900679	1	Follower
40	901089	1	Exhaust Baffle	88	900691	1	Compression Spring
41	900616	1	Exhaust O-Ring	89	900627	1	Negator Spring
42	403099	1	Retaining Ring	90	900720	1	Follower Core
43	403098	1	Piston Ring	91	900617	1	Follower Body
*44	900728	1	Piston Assembly	92	900724	1	Screw, Plastite 8-16 x 5/8"
*45	900680	1	Piston Bumper	93	901066	4	Screw, Plastite 8-16 x 3/4"
46	018924	1	Label, Li-Ion IM65A F16	94	902417	1	Nail Load Indicator Label
48	902416	1	Depth of Drive Indicator Label	95	018923	1	Handles labels assembly
49	900620	1	Front Channel	97	903502	1	Handle, Left
				98	902456	1	Cylinder Sleeve Assembly

- \* Indicates normal wear items
- Denotes Change
- Apply Loctite RC-620 (Green)

## SAFETY INSTRUCTIONS

WEAR EYE AND HEARING PROTECTION



Always wear eye and hearing protection when operating a nail tool.



# IM65A F16 Lithium

Part No. 013312 (EU), 013313 (UK)

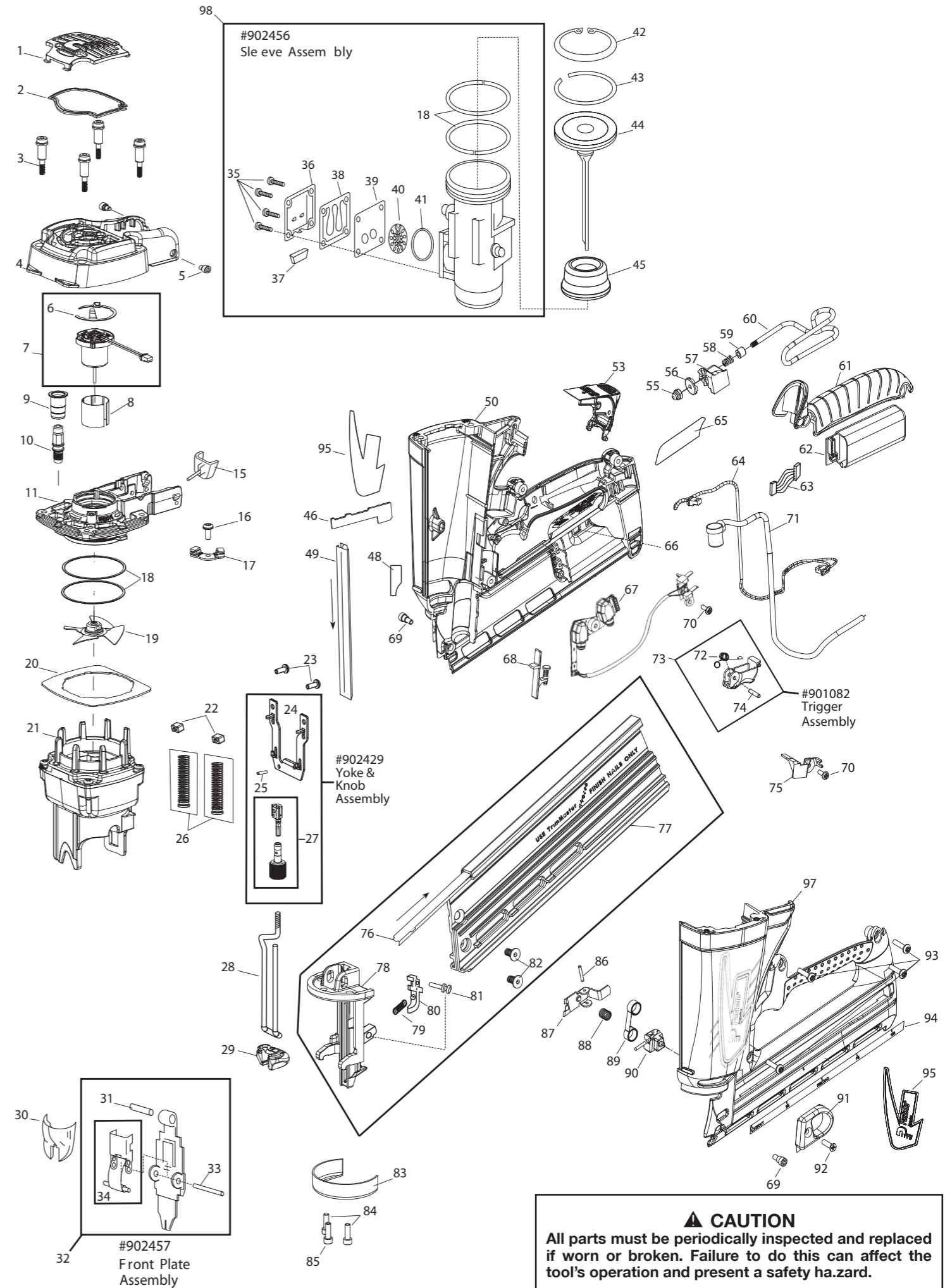

**CAUTION**  
All parts must be periodically inspected and replaced if worn or broken. Failure to do this can affect the tool's operation and present a safety hazard.