

# PIMATIC

## PIC-CYLINDERS

**Polar**  
—  
**teknik**

# PIC-CYLINDER SERIES

## Double acting cylinders

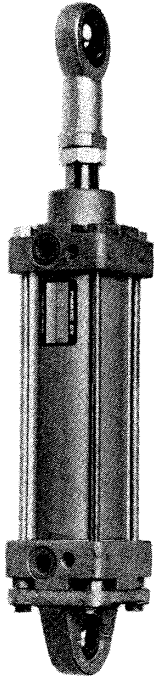

### Technical data

Adjustable pneumatic cushioning  
 Cylinder bores  $\varnothing$  32-320 mm  
 Maximum pressure 1,0 MPa (10 bar)  
 Cylinders conform to ISO 6431 and ISO 6430  
 Temperature range for standard versions  $-30^{\circ}\text{C} \dots +80^{\circ}\text{C}$   
 Operation medium standard cylinder compressed air (filtered and lubricated)  $40 \mu\text{m}$   
 Recommended lubricant Shell Tellus 37 or equivalent.

### Material specification for standard cylinder

End caps and body	Aluminium alloy
Piston	Aluminium
Rod	Hard chromed steel
Cushioning pistons	Aluminium or polyacetal
Wear ring	PTFE-grounded or thermoplast
Bearing	Steel housing with a self lubricating bearing
Tie rods and nuts	Stainless steel or zinc coated steel
Seals	Nitrile oil resistant synthetic rubber, temperature range $-30^{\circ}\text{C} \dots +80^{\circ}\text{C}$

### Special seals

Cylinders are delivered even with special seals and special exportations.  
 See page 3.  
 Temperature ranges concern continuous drift of cylinders.

### Cylinder thrust

The cylinder thrust table given below shows the theoretical thrusts at different line pressures. An efficiency of 80 % should be assumed due to frictional losses.

Cylinder bore mm	Rod $\varnothing$ mm	Piston area $\text{cm}^2$		Cushioning		Driving force + direction (Newton thrust)			
		Out	In	Length mm	Area $\text{cm}^2$	0,2 MPa	0,4 MPa	0,6 MPa	0,8 MPa
32	12	8	6,9	15	6	160	320	480	640
40	16	12,5	10,5	18	9,4	250	500	750	1000
50	20	19,6	16,5	19	13,7	390	780	1170	1560
63	20	31	28	24	26	620	1240	1860	2480
80	25	50	45	27	42	1000	2000	3000	4000
100	32	78	70	32	70	1560	3120	4680	6240
125	32	122	114	39	109	2440	4880	7320	9760
160	40	200	180	41	180	4000	8000	12000	16000
200	50	314	294	44	283	6280	12560	18840	25120
250	63	490	460	48	459	9800	19600	29400	39200
320	70	800	765	50	750	16000	32000	48000	64000

1 MPa = 10 bar    1 N = 0,102 kp

# PIC-CYLINDER SERIES

## Special cylinders

**PIC-01 Double rod cylinders**

**PIC-02 Tandem cylinders**

**PIC-03 Three-position cylinders**

Cylinders have same strokes and are mounted end to end.

**PIC-03 Four-position cylinders**

Cylinders have different strokes and are mounted end to end.

**PIC-04 Multiple position cylinders**

Cylinders consist of two or more cylinders joined together to get more than two defined end positions

**PIC-05 Cylinders with oil cushioning**

**PIC-09 Cylinders with magnetic piston for touch-free sensing of the position.**

Standard in bore sizes  $\varnothing$  32 to 125.

**PICP Cylinders with piston rod protected with gaiters.**

Attn. Piston rod is overlong, dimensioning in separate table.

**PICS Cylinders with seals giving constant friction**

**PICT Cylinders with special seals for using without lubrication**

**PICV Cylinders with viton seals for high temperatures**  
 $-20^{\circ}\text{C}$ — $+150^{\circ}\text{C}$ .

**PICF Cylinders with seals for low temperatures**  
 $-50^{\circ}\text{C}$ — $+80^{\circ}\text{C}$ .

**PICH Cylinders with piston rod of stainless steel**

**PICK Cylinders steadfast against corrosion**

**PIC..pn Cylinders according to customer's specifications**

**PICN Cylinders operating with fluid (oil, water)**

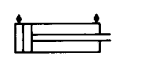
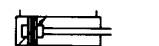
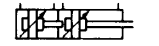
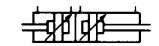
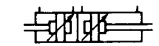
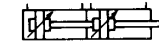
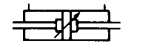

# DIMENSION TABLES OF PIC-CYLINDER SERIES

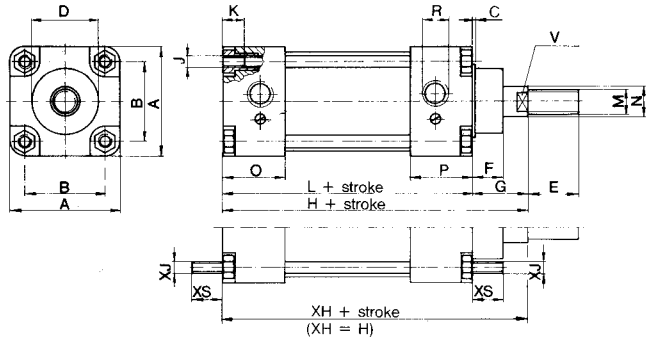

## Basic cylinder

NS	32	40	50	63	80	100	125	160	200	250	320
A	45	51	64	75	95	110	136	172	216	268	342
B	33	37	47	56	70	84	104	134	163	202	266
C	—	4	3	4	6,5	5	5	8	8	10	10
D	28	36	42	48	60	60	72	90	108	126	144
E	22	24	32	32	40	40	54	72	72	84	96
F	16,5	19,5	22	21	28,5	35	35	50	65	70	80
G	26	30	37	38	45	52	64	82	95	105	120
H	120	135	143	157	175	188	226	258	275	305	340
J	M6	M6	M6	M8	M10	M10	M12	M16	M16	M20	M24
K	10	10	10	12	14	14	16	20	20	—	—
L	94	105	106	119	130	136	162	176	180	200	220
M	M10x1,25	M12x1,25	M16x1,5	M16x1,5	M20x1,5	M20x1,5	M27x2	M36x2	M36x2	M42x2	M48x2
N	12	16	20	20	25	32	32	40	50	63	70
O	25	28,5	28	29	32,5	38	43	46	46	57	65
P	25	28,5	28	34	32,5	38	43	46	46	57	65
R	R1/8	R1/4	R1/4	R3/8	R3/8	R1/2	R1/2	R3/4	R3/4	R1	R1
V	10	14	17	17	22	27	27	35	43	50	54

## Tie rods extended X, front or rear

NS	32	40	50	63	80	100	125	160	200	250	320
XJ	M6	M6	M6	M8	M10	M10	M12	M16	M16	M20	M24
XS	17	17	23	23	28	28	34	42	42	50	60

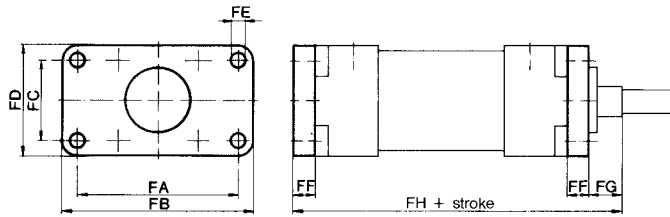

## Flange F, front F1 rear F2

NS	32	40	50	63	80	100	125	160	200	250	320
FA	64	72	90	100	126	150	180	230	270	330	400
FB	80	90	108	120	150	185	220	280	320	385	460
FC	32	36	45	50	63	75	90	115	135	165	200
FD	45	55	64	75	91	110	136	172	216	268	342
FE	7	9	9	9	12	14	16	18	22	26	33
FF	10	10	12	13	15	17	19	22	25	25	30
FG	16	20	25	25	30	35	45	60	70	80	90
FH	130	145	155	170	190	205	245	280	300	330	370

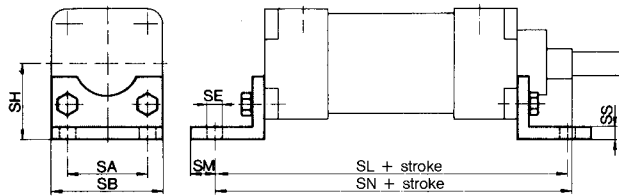

## End angles S

NS	32	40	50	63	80	100	125	160	200	250	320
SA	32	36	45	50	63	75	90	115	135	165	200
SB	45	51	64	75	91	110	136	172	216	268	342
SE	7	9	9	9	12	14	16	18	22	26	33
SH	32	36	45	50	63	71	90	115	135	165	200
SL	142	161	170	185	210	220	250	300	320	350	390
SM	6	8	8	12	12	12	20	20	32	25	25
SN	144	163	175	190	215	230	270	320	345	380	425
SS	7	7	8	11	12	12	12	10	10	10	12

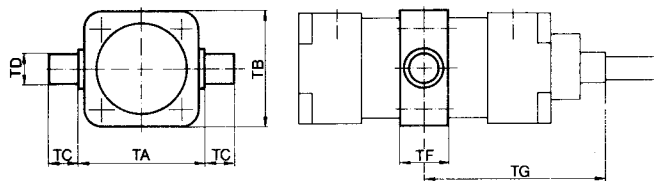

## Trunnion T

NS	32	40	50	63	80	100	125	160	200	250	320
TA	50	63	75	90	110	132	160	200	250	320	400
TB	48	56	70	82	106	126	156	192	242	302	382
TC	12	16	16	20	20	25	25	32	32	40	50
TD e9	12	16	16	20	20	25	25	32	32	40	50
TG min	61	71	79	88	95	110	127	148	166	192	220
TF	20	25	28	32	35	36	40	40	50	60	70

Norm. TG = G + (L + isku)/2

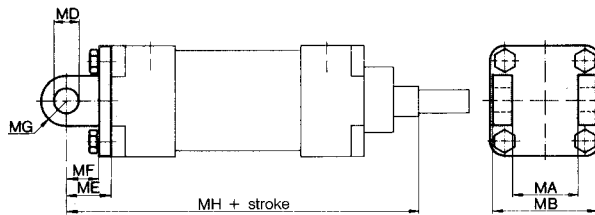

## Rear clevis M

NS	32	40	50	63	80	100	125	160	200	250	320
MA h 14	26	28	32	40	50	60	70	90	90	110	120
MB h 14	45	52	60	70	90	110	130	170	170	200	220
MD H 9	10	12	12	16	16	20	25	30	30	40	45
ME	22	25	27	33	35	42	49	57	60	70	80
MF	17	21	21	25	25	31	38	44	46	54	60
MG	10	11	11	16	16	20	30	35	45	42	42
MH	142	160	170	190	210	230	275	315	335	375	420

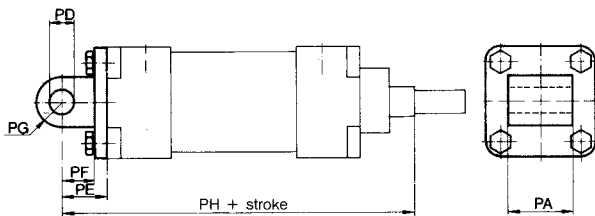

## Rear eye P

NS	32	40	50	63	80	100	125	160	200	250	320
PA	26	28	32	40	50	60	70	—	—	—	—
PD H9	10	12	12	16	16	20	25	—	—	—	—
PE	22	25	27	33	35	42	49	—	—	—	—
PF	15	17	18	23	23	28	32	—	—	—	—
PG	10	12	12	15	16	20	25	—	—	—	—
PH	142	160	170	190	210	230	275	—	—	—	—

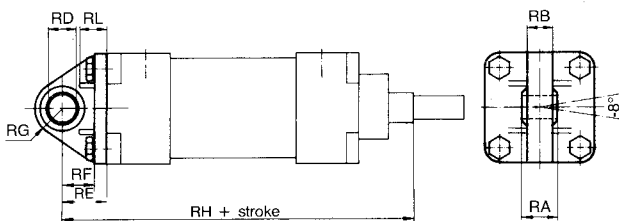

## Spherical bearing R

NS	32	40	50	63	80	100	125	160	200	250	320
RA h 12	14	16	16	21	21	25	31	37	37	40	43
RB	11	14	15	18	19	22	28	30	30	33	40
RD H9	10	12	12	16	16	20	25	30	30	40	45
RE	22	25	27	33	35	42	49	57	60	70	80
RF	16	19	20	25	25	31	35	42	46	52	55
RG	15	18	22	22	27	28	33	43	45	50	55
RH	142	160	170	190	210	230	275	315	335	375	420
RL	—	—	—	—	—	—	—	38	44	70	54

# ADDITIONAL MOUNTINGS

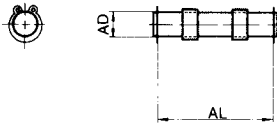

## Pivot A

NS	32	40	50	63	80	100	125	160	200	250	320
A ex. A-32-1045 = ADAL											
P + M	1046	1253	1261	1671	1691	20111	25131	30171	30171	40201	45221
B/R + U	1026	1228	1232	1640	1652	2060	2570	3086	3086	40111	45123
B/R + Z	1035	1241	1252	1654	1668	2080	2590	30107	30107	40133	45165
P + Z	1046	1253	1263	1673	1693	20115	25122				
M + Z	1066	1277	1291	16104	16133	20165	25182	30234	30234	40284	45324

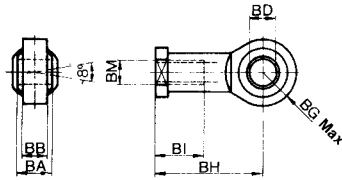

## Piston rod end (spherical) eye bearing B (ISO 8139)

NS	32	40	50	63	80	100	125	160	200	250	320
BA h12	14	16	21	21	25	25	37	43	43	49	60
BB	10,5	12	15	15	18	18	25	30	30	35	40
BD H9	10	12	16	16	20	20	30	35	35	40	50
BG Max	14	16	21	21	25	25	35	40	40	45	58
BH	43	50	64	64	77	77	110	125	125	142	160
BI	20	22	30	30	36	36	51	56	56	60	65
BM	M10x1,25	M12x1,25	M16x1,5	M16x1,5	M20x1,5	M20x1,5	M27x2	M36x2	M36x2	M42x2	M48x2

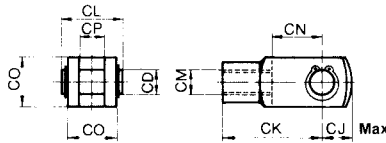

## Piston rod clevis assembly C (ISO 8140)

NS	32	40	50	63	80	100	125	160	200	250	320
CD H9	10	12	16	16	20	20	30	35	35	40	50
CJ Max	16	19	25	25	32	32	45	57	57	77	88
CK	40	48	64	64	80	80	110	144	144	168	192
CL	26	31	39	39	49	49	65	84	84	95	110
CM	M10x1,25	M12x1,25	M16x1,5	M16x1,5	M20x1,5	M20x1,5	M27x2	M36x2	M36x2	M42x2	M48x2
CO	20	24	32	32	40	40	55	70	70	85	96
CN	20	24	32	32	40	40	54	72	72	84	96
CP	10	12	16	16	20	20	30	35	35	40	50

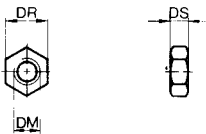

## Piston rod nut D

NS	32	40	50	63	80	100	125	160	200	250	320
DM	M10x1,25	M12x1,25	M16x1,5	M16x1,5	M20x1,5	M20x1,5	M27x2	M36x2	M36x2	M42x2	M48x2
DR	17	19	24	24	30	30	41	55	55	65	75
DS	5	6	8	8	10	10	12	18	18	21	24

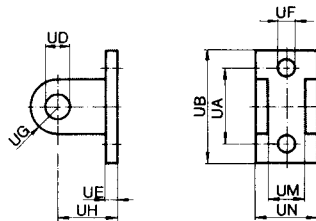

## Clevis foot U (for front or rear hinge)

NS	32	40	50	63	80	100	125	160	200	250	320
UA	30	38	46	58	70	88	108	138	170	212	275
UB	45	55	64	79	94	118	145	182	215	265	340
UD	10	12	12	16	16	20	25	30	30	40	45
UE	6	8	5	10	12	14	18	14	19	22	23
UF	7	9	9	12	14	18	22	26	26	40	38
UG	11	15	15	19	19	24	30	33	33	40	45
UH	24	27	30	36	40	45	55	65	70	80	90
UM	15	17	22	22	26	26	38	44	44	50	61
UN	26	28	32	40	50	60	70	90	90	110	120

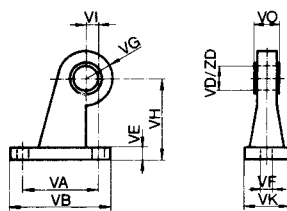

## Bracket V (for central trunnion T)

NS	32	40	50	63	80	100	125	160	200	250	320
VA	30	38	46	58	70	88	108	138	170	212	275
VB	45	55	64	79	94	118	145	182	215	265	340
VD H9	12	16	16	20	20	25	25	32	32	40	50
VE	7	9	8	10	11	13	13	18	18	18	23
VF	7	9	9	12	14	18	22	26	26	32	38
VG	13	15	17	21	21	25	28	33	33	40	45
VH	32	36	45	50	63	71	90	115	135	165	200
VI	7	9	10	12	14	17	21	25	25	30	35
VK	16	18	25	28	34	40	45	60	60	60	70
VO	10	15	15	20	21	27	25	30	30	40	50

## Bracket Z, (for mounting M, P, R, B)

NS	32	40	50	63	80	100	125	160	200	250	320
ZD	10	12	12	16	16	20	25	30	30	40	45
ZO	10	12	15	16	21	27	25	30	30	40	50

## Example combinations

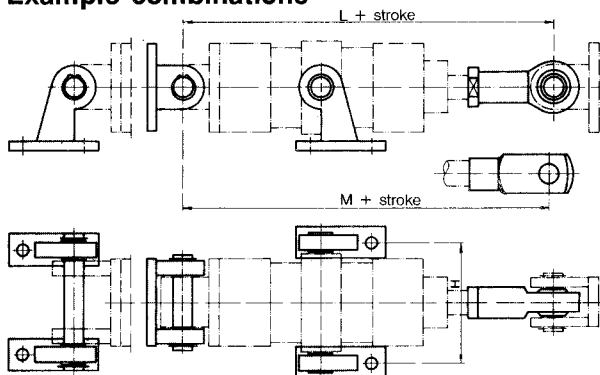

## Dimensions (with mountings)

NS	32	40	50	63	80	100	125	160	200	250	320
H	62	80	92	112	132	160	187	232	282	362	452
L Min	190	216	242	262	297	317	397	458	478	538	604
M Min	187	214	242	262	300	320	397	477	497	564	636

# ORDERING EXAMPLE, STORE CYLINDERS AND WEIGHTS

## Ordering example

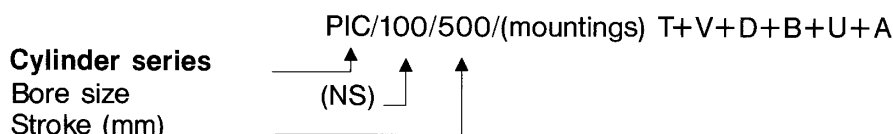

- Cylinder series  
 Bore size  
 Stroke (mm)
- 1 pc mounting T-100
  - 1 pair mounting V-100
  - 1 pc mounting D-100
  - 1 pc mounting B-100
  - 1 pc mounting U-100
  - 1 pc mounting A-100-2060

(Dimension TG quoted when ordering)  
 Side trunnion is normally fitted midway between end caps unless dimension TG ( $TG = G + (L + \text{stroke})/2$ ) is specified.

## Standard strokes in mm X-stocked strokes in mm

Bore size mm	Piston rod diam. mm		STOCK AND STANDARD STROKES MM ISO 4393															
			NS	25	50	80	100	125	160	200	250	320	400	500	630	800	1000	
32	12	R 1/8"	32	x	x	x	x	x	x	x	x							
40	16	R 1/4"	40	x	x	x	x	x	x	x	x	x						
50	20	R 1/4"	50	x	x	x	x	x	x	x	x	x	x					
63	20	R 3/8"	63		x	x	x	x	x	x	x	x	x	x				
80	25	R 3/8"	80		x	x	x	x	x	x	x	x	x	x				
100	32	R 1/2"	100		x	x	x	x	x	x	x	x	x	x				
125	32	R 1/2"	125				x	x	x	x	x	x	x	x				
160	40	R 3/4"	160						x	x	x	x	x	x				
200	50	R 3/4"	200															
250	63	R 1"	250															
320	70	R 1"	320															

Other strokes 1—3000 mm are available in short delivery

## Weights of cylinders and mountings

Weights kg	Cylinder bore size Ø in mm										
	32	40	50	63	80	100	125	160	200	250	320
Basic cyl.	0,72	1,0	1,1	1,5	2,7	3,6	6,8	15,3	22,9	30,7	65,0
add. stroke*	0,25	0,32	0,40	0,43	0,80	1,0	1,3	2,2	3,0	4,5	6,9
Mountings											
F	0,07	0,09	0,16	0,22	1,1	1,9	3,4	6,4	10,8	15,9	31,5
S	0,04	0,05	0,08	0,14	0,17	0,28	0,76	1,7	2,4	3,8	6,5
T	0,13	0,20	0,31	0,48	0,78	2,2	2,5	3,3	9,0	15,0	29,8
M,P	0,07	0,11	0,15	0,25	0,40	0,72	1,4	2,1	3,2	13,5	22,0
R	0,07	0,12	0,17	0,26	0,41	0,65	1,2	1,9	2,8	12,0	19,0
B	0,07	0,10	0,21	0,21	0,38	0,38	1,0	2,0	2,0	3,1	4,2
C	0,14	0,21	0,48	0,48	0,74	0,74	1,3	2,9	2,9	4,5	5,8
D	0,01	0,02	0,03	0,03	0,06	0,06	0,16	0,39	0,39	0,62	0,93
A	0,03	0,05	0,06	0,11	0,14	0,27	0,50	0,90	0,95	1,9	2,3
U	0,03	0,05	0,07	0,14	0,24	0,36	1,7	3,1	4,0	7,0	10,5
V,Z (pair)	0,06	0,09	0,18	0,30	0,50	0,83	3,3	6,6	8,7	15,0	32,0

\* Add. stroke/100 mm

# SPARE PARTS

Seal kit for cylinder PIC consists of parts  
No. 12...16. +8.  
Ordering example: Seal kit PIC-80.

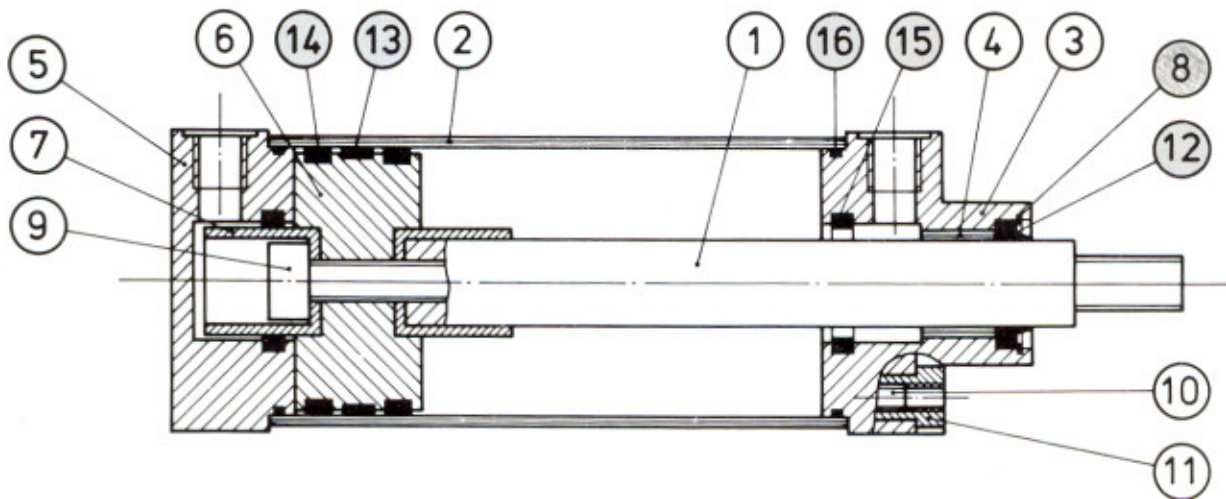

Detail	Pcs	Item
1	1	Piston rod
2	1	Cylinder tube
3	1	Front end cap
4	1	Front bearing "delivered only together with front end cap"
5	1	Rear end cap
6	1	Piston
7	2	Cushioning piston
8	1	Circlip
9	1	Mourtingsscrew for piston
10	4	Tie rod
11	8	Nut for tie rod
12	1	<b>Seal for piston rod</b>
13	1	<b>Wear ring</b>
14	2	<b>Piston seal</b>
15	2	<b>Seal for cushioning</b>
16	2	<b>Seal body/end caps</b>